

SEWING FOCUS

TECHNICAL SEWING INFORMATION

SERVICEHOUSE

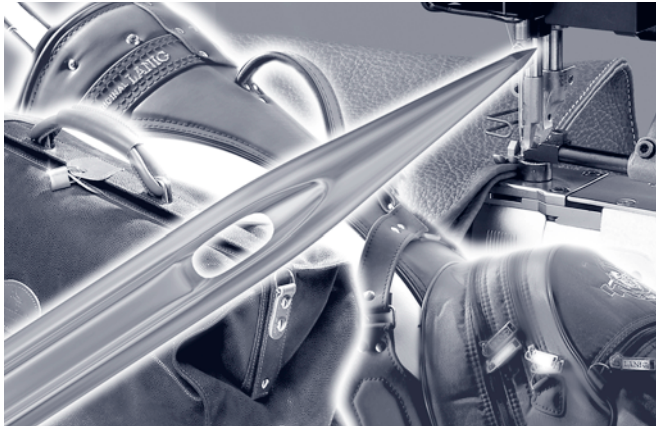

Luggage, Bags, Travel and Leather Accessories

Checklist for Sewing Luggage, Bags, Travel and Leather Accessories

Sewing Parameters: SCHMETZ Tip:

Needle size	NM 80 – 160	SIZE 12 – 23
--------------------	----------------	-----------------

Depending on the thickness of the material. We recommend the use of the SCHMETZ SERV 7 needle.

Needle point For production of luggage, bags, travel and leather accessories mostly round points and ball points are used. Cutting points are also used with various types of incision.

Sewing thread For sewing luggage, mostly multi filament threads made from 100 % polyester or polyamide, for leather goods (small leather goods) polyester spun yarns, for watchstraps bonded polyamide 6.6 threads and for belts core spun threads made from polyamide are used.

Machine In the production, different types of sewing machines are used, such as flatbed, postbed and free-arm sewing machines. In the belt and waistband industry also automatic machinery are used. For decorative stitching, CNC controlled automated sewing machines are used.

Other factors:

Thread tension The required thread tension depends on fabric, sewing thread and sewing machine. The thread tension should be as low as possible to allow an optimal stitch formation.

Stitch type Generally in the manufacture of luggage, the double lock stitch (stitch type 301 and 304) is used, double chain stitch (stitch type 401) or overedge stitch (401.503 or 401.505) are sometimes used when sewing the lining.

Stitch density The higher the stitch density, the better the strength of the seam. The stitch density depends on the desired seam appearance.

Quick Reference for Typical Sewing Problems in Manufacturing Luggage, Bags, Travel and Leather Accessories

Symptoms	Effect	Cause
----------	--------	-------

Skip stitches/Thread breakage

No interlacing/interlooping of needle thread and bobbin/looper thread	Sub-standard, defective seam appearance	Incorrect thread tension
Needle thread breaks	Thread breakage after skip stitch	Incorrect needle system
Ravelling of the needle thread	Jamming of the sewing thread due to stitch holes which are stuck together	Needle incorrectly fitted
		Mechanical damage to needle, throat plate, feed etc.
		Jamming of the sewing thread between needle and fabric
		Incorrect thread guidance
		Needle deflection due to extremely thick layers of material at cross seams

Needle breakage

	Broken needle parts remain in fabric	Needle deflection too heavy
	Material is damaged	Damaged point, resulting in excessive penetration force
		Needle size and material thickness are not adjusted to each other
		Use of an undersized needle

Solution

NM SIZE



Point style



Thread



Machine



Use the SCHMETZ SERV 7 needle

Adjust needle size to the material and amount of layers

Change needle regularly (after every shift or in a shorter interval depending on the stress)

Check needle eye and groove for damage, if in doubt: change needle

Check point for damage

Adjust sewing thread size to the needle size

Optimize thread tension

Optimize the hook/looper setting

Examine the thread guiding elements

Adjust the sewing accessories such as throat plate, feed etc. depending on material thickness and sewing thread/needle

Change worn out or defective sewing accessories regularly, such as thread guiding elements, hook/looper, throat plate etc.

Use the SCHMETZ SERV 7 needle

Adjust needle size to the material and amount of layers

CAUTION: Change needle regularly (after every shift or in a shorter interval depending on the stress)

Check and adjust the material transport

Adjust the sewing accessories such as throat plate, feed etc. depending on material thickness and sewing thread/needle

CAUTION: After a needle breakage it is necessary to check the throat plate for damage

Quick Reference for Typical Sewing Problems in Manufacturing Luggage, Bags, Travel and Leather Accessories

Symptoms	Effect	Cause
----------	--------	-------

Material damage



Material damage	Reduced tensile strength of the material	Oversized needle and/or wrong point style
	Sub-standard, defective seam appearance	Defective/worn out needles
	Reduced seam strength	Use of wrong feed

Uneven seam appearance











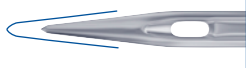



Stitch sequence is irregular, resulting in a zig-zagging seam	Reduced seam strength	Incorrect adjustment of the sewing accessories such as hook/looper, feed etc.
	Sub-standard, defective seam appearance	Incorrect balance of thread tension
		Incorrect thread guidance
		Needle deflection too heavy
		Damaged thread guiding elements

Thermal damage

Individual layers of material are sticking together	Needle thread breaks	Excessive needle temperature due to friction especially when sewing densely woven fabrics
	Needle eye is clogged	Excessive sewing speed
	Needle groove is clogged	Needle smeared or needle eye clogged with melted residue
		Melting of the thread surface and as a result mechanical breakage of the weakened thread

Solution			
NM SIZE	Point style	Thread	Machine
			
<p>Use the SCHMETZ SERV 7 needle</p> <p>Adjust needle size to the material and amount of layers</p>	<p>R Normal round point</p> <p>SES Light ball point</p> <p>CAUTION: Change needle regularly (after every shift or in a shorter interval depending on the stress)</p>	<p>Choose the right sewing thread size according to the needle size and the fabric</p>	<p>Adjust the sewing accessories such as throat plate, feed etc. depending on material thickness and sewing thread/needle</p> <p>Check and adjust the material transport</p>
<p>Use the SCHMETZ SERV 7 needle</p> <p>Adjust needle size to the material and amount of layers</p>		<p>Optimize thread tension</p> <p>Check thread flow</p> <p>Choose the right sewing thread size according to the needle size and the fabric</p>	<p>Examine the thread guiding elements</p> <p>Check and adjust the material transport</p>
<p>BLUKOLD needle with Teflon coating. This needle coating prevents or greatly reduces the adhesion of melted residues</p> <p>CAUTION: The use of the BLUKOLD needle does not reduce the needle temperature which is caused by excessive sewing speeds</p>		<p>Select a well finished sewing thread</p> <p>Alternatively use an extra thread lubricant (e.g. silicone oil)</p>	<p>Reduce sewing speed</p> <p>Use needle cooling through compressed air</p>

Selection of Point Style and Needle Size

Material	Number of layers	Needle size NM / SIZE	Point style
Textile materials, leather-like materials	2 – 4	80 – 120 / 12 – 19	R normal round point 
Very hard faux leather	2 – 4	80 – 120 / 12 – 19	SD1 round point with small triangular tip 
Light coated materials	2 – 4	80 – 120 / 12 – 19	SPI acute round point 
Material combinations with knitted fabrics	2 – 4	80 – 120 / 12 – 19	SES light ball point 
Fine leather, faux leather, PVC/ PUR coated fabrics	2 – 4 and up	60 – 70 / 8 – 10 80 – 100 / 12 – 16	SD1 round point with small triangular tip 
Dry, hard leather	2 – 4 and up	100 – 140 / 16 – 22 140 – 280 / 22 – 28	D triangular point 
			DI diamond point 
			VR reverse twist spear point PCR, 
			PCL narrow wedge point 
			S narrow cross point 
All kind of leather, thick cardboard, rubber foil	2 – 4 and up	70 – 130 / 10 – 21 140 – 160 / 22 – 23	LR reverse twist point 
			LBR wide reverse twist point 
			LL twist point 
			PCR, PCL narrow wedge point 
			S narrow cross point 

In manufacturing luggage, bags, travel and leather accessories the use of the SERV 7 needle version with the appropriate point style should be considered, depending on the field of application and the sewing operation.



Contents

1. Manufacturing of luggage, bags, travel and leather accessories
 - 1.1 Typical sewing problems
 - 1.2 Quality seams with the right sewing parameters
2. Selection of the right needle
 - 2.1 Needle size
 - 2.2 Point style
 - 2.3 SERV 7 needle construction
 - 2.4 Changing of the needle
3. Selection of sewing threads and stitch parameters
 - 3.1 Composition and size of the sewing thread
 - 3.2 Stitch type
 - 3.3 Stitch density
 - 3.4 Thread tension
4. Sewing machines for the manufacturing of luggage, bags, travel and leather accessories
 - 4.1 Feed
 - 4.2 Throat plate/Throat plate aperture size
 - 4.3 Sewing speed
5. Our advice
6. SERVICEHOUSE –
An overview of our services

1. Manufacturing of luggage, bags, travel and leather accessories

The first handbags emerged at the beginning of the 19th century as fashion began to change. The new narrow classic style gowns were too tight to hide the traditional dress pouches. These pouches were made from simple washable cotton, worn underneath clothing and tied around the waist; they were accessible through side slots in the upper gown. Later on, these dress pouches became part of the inner lining of skirts. Separate bags, however, were beginning to gain acceptance and for many women they were now an essential accessory.

Throughout the 20th century, the handbag was a true reflection of women's endeavors and activities. On the one hand, bags are entirely practical, but on the other, they are objects of the imagination that permeate our dreams and secrets. Psychoanalysts have long since exposed the symbolic significance of the handbag; and it has always been the object of mockery for cartoonists and witty writers.

During the course of the decades, the handbag became the object of women's passionate consumer wishes. The most successful handbags were associated with such female role models as Grace Kelly, Jacqueline Onassis, Margaret Thatcher and Queen Elizabeth II and reached cult status. The design and decoration of handbags reflected all art movements, from art nouveau to surrealism to pop art; with an increasing number of women at work, purpose and shape of the bag has changed again since the mid-eighties.



1.1 Typical sewing problems

Laminated and coated materials such as belts, suit cases and organizers, as well as synthetic fibers on rucksacks, bags or purses may cause the needle to become sticky when sewing speed and therefore temperature rises. If the melting point of synthetic materials is reached, melted residue may form around the stitch hole, which in turn will be transferred to the surface of the needle. As a result, the sewing thread no longer runs without tension, but rather blocks. The seam is faulty and of inferior quality. Typical results are not only thread breakage and skip stitches. Often, the material's melting point is so low that even with medium sewing speed the edges melt into the stitch hole and the material layers stick together. The needle surface smudges. As long as the needle moves, the residue is still malleable and the friction situation will be even less favorable. If the machine stops – which causes the needle to cool down immediately – the melted residue becomes hard and the needle may not be used for much longer.

In the manufacture of products where one has to sew through tough cardboard, thick leather or hard synthetic materials, needle breakages and skip stitches may not be ruled out. Especially in places where buckles and fasteners may require up to ten layers the deflection of the needle is virtually guaranteed. The needle in that case departs from the hook/looper too much, so that it can no longer catch the needle thread loop. The result are skip stitches. It may also happen that the needle point is deflected to such a degree that it damages the throat plate. The costs for spare parts and downtime would therefore be significantly increased.

When sewing hard, tough materials and composites, needle deflection may lead to an uneven seam appearance.

Typical sewing problems are:

- Skip stitches / Thread breakage
- Material damage
- Thermal damage

1.2 Quality seams with the right sewing parameters

In order to optimize quality seams and to avoid problems of manufacture such as skip stitches, thread breakage or thermal damage when sewing luggage, bags, travel and leather accessories, care must be taken that there is a smooth interplay of material, needle, thread and machine settings. After all, the quality of the seam influences the seam's durability as well as the appearance of the end product.

Needle

2. Selection of the right needle

Choosing the right needle and point style for the material is extremely important for an undamaged seam and a perfect end product. The material is the main factor when choosing a point style for a particular sewing operation. The point style (for example in the case of fashionable decorative seams) is crucial for achieving the desired effect.

If the influence of the needle and point style on seam quality is not taken into account during preparation phase of the work, there can be no guarantee of damage-free sewing.

The choice of needle is always guided by the material quality, the number of layers and material combination.

2.1 Needle size

Before deciding on a point style, needle size should be determined. It is important to bring this into line with the thread so that it can pass the needle eye with as little friction as possible. As a rule, the size of the needle eye is around 40 % of the needle size (NM).

The choice of needle size is dependent on fabric, number of layers, thread and finish. No damage can be expected when using the right needle diameter and matching needle eye.

Hard materials require correspondingly thick needles – in the case of luggage this is often NM 140 and higher. It is thus necessary to choose appropriately thick sewing thread. Otherwise the stitch hole would not be completely filled and

the seam appearance would not be ideal. On the other hand, the sewing thread must not be too thick either, so that when the thread passes through the eye of the needle friction is not too high and the sewing thread is less likely to break.

In order to avoid material and fabric damage, the needle should be as thin as possible. If the needle is too thick for the material or if it has an unsuitable point, this may lead to breakage or to damage to the material thread.

For watch-straps and belts, and in the case of handbag embroidery it is sometimes customary to use CNC controlled sewing automats. Here, too, needle size must be chosen carefully in order to meet the special demands of multi directional sewing.

You can find an overview of the recommended needles sizes in the table on page 6.

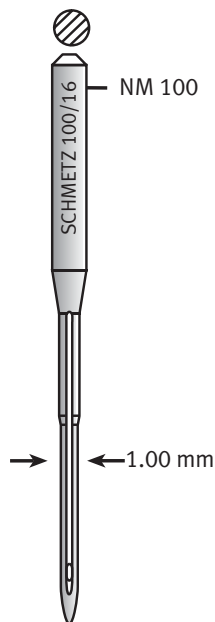

2.2 Point style

Point style is almost as important for a smooth production process as is the right needle size.

In general, synthetic materials should be sewn using round and ball points, which displace the material rather than cut it. The range is from the normal round point “R” for fabrics and leather-like materials to the acute round point “SPI” for light coated materials to the light ball point “SES” for material combinations with knitted fabrics.

The normal round point “R” is the standard point style. With its pointed conical shape it pierces the fabric threads and thus produces a very straight seam. When sewing different combinations of materials, point style is often a matter of compromise. Therefore, the “R” point is used most often. A further field of application is tougher leather, which a round point can still pierce without any problem.

In the case of coated materials and membranes, e. g. Gore-Tex® and Sympatex®, the “SPI” point enables exact piercing due to its very slim acute point. The acute point style can easily find its way through the very tight fabric and produces a tidy and straight seam appearance.

The “SPI” point is therefore often used for top-stitching seams. Seam puckering is also kept to a minimum.

Compared with the “normal” round point, the tip of the “SES” point is hemispherical and can therefore avoid material damage. At the point of penetration, a small ball point can push aside or displace fabric threads more easily.

This needle point is not only used for knitted fabrics, but also for light, tightly woven materials.

R normal round point



SPI acute round point



SES light ball point



In the case of very tough types of imitation leather, a round point with a small triangular tip “SD1” may be used in order to ensure centered incision. This point form constitutes a compromise between a cutting point and a round point (displacement point).

The small triangular tip cuts around 10 % of the stitch hole, 90 % are displaced by the conical point. The “SD1” point cuts the material very carefully.

This point is particularly suitable for multi directional sewing (in the case of sewing automats), especially in combination with the SERV 7 needle, since stitch placement remains the same in all sewing directions.

R normal round point



SD1 round point with small triangular tip



The needles for sewing leather, leather accessories or similar materials as cardboard and plastic foils have a cutting edge. These special needles penetrate the fabric more easily due to their ability to cut. Although materials with a homogenous structure will be weakened by the incision, their general strength however will not be significantly impaired if the right point style is selected and the right stitch density is used.

The choice of cutting point depends on the thickness of the leather, type of seam, seam function and the desired seam appearance (e.g. decorative seam).

Stitch hole and seam appearance vary depending on whether the tip's cross-section is lens-shaped, diamond-shaped or triangular: Decorative seams can be produced easily by choosing a particular cutting point from the range of needles. The "LR" point for example cuts the leather at an angle of 45° to the direction of the seam, which together with the right sewing yarn results in a decorative seam with a stitch position slightly diagonal to the left.

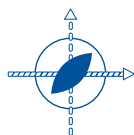

LR reverse twist point



Particularly when sewing strong, hard leather it is therefore wise to resort to a twisted point groove needle. The choice of right twisted (PCR) or left twisted (PCL) point groove of the narrow wedge point "P" depends on how the hook takes the thread, this gives the thread more room and protects it from being squeezed against the cutting edge. Seams that are put under a lot of strain, as it is commonly the case with seams of suitcases, bags and rucksacks, require stitches that are very close together. The lens-shaped narrow wedge point "P" enables this by cutting the material diagonally to the sewing direction. This ensures that there is enough distance between the individual stitches and there is then no danger that the material is perforated by touching stitch holes. The small distances between stitches result in fine, pearl-string-like seams – as top seams – and are very decorative.

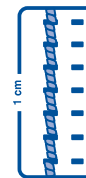
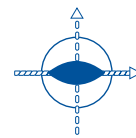

P narrow wedge point



PCL narrow wedge point with left twisted point groove



PCR narrow wedge point with right twisted point groove
It is especially used as a left needle in a 2-needle machine



In the manufacture of bags and suitcases with coarse decorative seams or belts and braces the narrow cross point "S" with lens-shaped incision in the direction of the seam is often used, when working with thick sewing threads and large dis-

tances between stitches. Since the stitches are parallel to the seam this gives the seam a straight appearance.

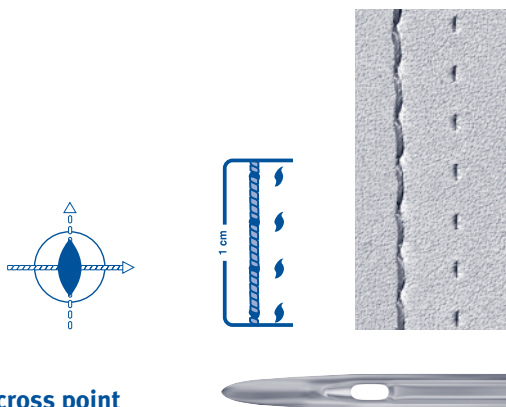

S narrow cross point

With all double lock stitch machines whose hook/looper is positioned to the left of the needle, a twist shift occurs with Z-twisted thread, which can easily lead to thread breakage. In order to counter this phenomenon, the use of needles with a right twisted point groove has proved useful. The sewing thread in this case is not pulled across the edge of the needle eye, but rather lies protected within the groove.

PLEASE NOTE: When using cutting points, attention must be paid that stitch density is not too high. This would result in the leather being perforated. As a result, the seam would be weakened or even destroyed.

2.3 SERV 7 needle construction

Differing sewing requirements and different numbers of material layers demand a needle which produces seams of the desired quality without problems.

Skip stitches impair the sequence and the strength of the seam and therefore influence the quality of the finished product dramatically.

The special features of SERV 7 needles are the so-called hump scarf and the extra reinforced blade. Both serve to avoid skip stitches and needle breakage. This special needle type comes in a range of several point styles – different round points or “SD1” point – for the different requirements of the respective materials.

In order to avoid material damage, the needle diameter needs to be as small as possible. This applies to the sewing of leather as well as textile fabrics.

The blade reinforcement makes the needle especially stable and far less likely to “bend”. Needle breakage is thus minimized and the centric penetration produces a better seam appearance. In addition, the low needle deflection also serves to avoid skip stitches.

With the right combination, needle size can often be the one below. When sewing many layers, the stability of the needle is of great importance. Needles without blade reinforcement can be deflected easily if the material is very thick. Needle incision is no longer centered and the result is an uneven seam appearance. Needle breakage may also be possible.

SCHMETZ Tip:
Benefit 1: SERV 7 needle has higher stability increasing needle life.

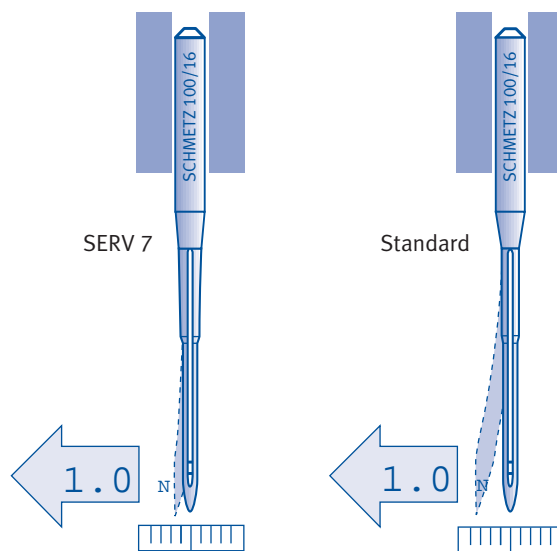

Besides material damage skip stitches are a common problem. Skip stitches are produced if the loop of the needle thread which is formed during stitch formation is not caught by the hook point interrupting the interlacing of needle thread and bobbin thread. Skip stitches are influencing the direction and the strength of the seam and thus significantly

SCHMETZ Tip:

Benefit 2: SERV 7 hump scarf produces optimum loop formation and prevents skip stitches.

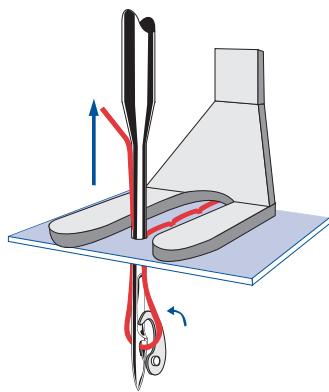

SCHMETZ SERV 7

The SCHMETZ SERV 7 needle improves the quality and appearance and reduces sewing problems.

2.4 Changing of the needle

The needle should be exchanged often or at regular intervals, no later, however, than at the beginning of a shift, in order to avoid sewing with a damaged needle point. Worn or damaged needle points lead to material damage. Since even minimal damage to the needle point can no longer guarantee a damage-free incision, it is essential to check the needle regularly to ensure the high quality of the seam and optimal seam appearance.

Sewing thread

3. Selection of sewing threads and stitch parameters

Luggage, bags, travel and leather accessories are subject to much wear and tear. It must therefore be ensured that the high demands of heavy-duty seams are met and that they can justifiably be called quality seams.

3.1 Composition and size of the sewing thread

Material and size of the sewing thread must have high abrasive strength so that they do not weaken through friction with often-used products or during daily use. Therefore, when sewing suitcases, luggage and bags, mostly stable, durable and high-strength polyester multifilament yarns or multifilament yarns made from tear proof and abrasive-proof polyamide 6.6 are used. Characteristics such as being tear-proof and abrasive-proof, light and weather proof and acid resistance are essential when choosing sewing thread. Powerful core spun threads made from 100 % polyester are used in the manufacture of small leather goods, toilet-bags and similar.

Watch-straps are sewn using bonded polyamide 6.6 continuous filament yarns, so that the end of the seam may be welded.

For belts, due to seam appearance, so-called core spun threads from No. 40 to No. 8 are used as upper thread. The lower thread is also core spun, but, due to the greater length of the lower thread, it is usually one or two sizes thinner. Sometimes, the same continuous polyamide sewing threads are used as for watch straps, except much thicker (from No. 40 to No. 8).

3.2 Stitch type

When sewing luggage, bags, travel and leather accessories, the double lockstitch (stitch type 301) is used most often.

When sewing hard and brittle materials, stitch formation of needle and bobbin thread in the middle of the sewing good is very unlikely due to the low elasticity of the material. Stitch

formation is therefore often on the material's underside (see stitch type 301). Although this makes sewing easier, it can cause the finished product's bobbin thread to break more easily when used heavily.

Stitch type 301 – double lockstitch interlaced at the underside of the sewing good

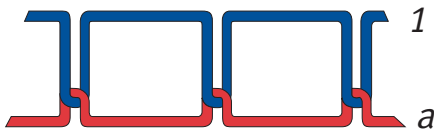

Stitch type 304 – double lockstitch zig-zag for decorative stitching

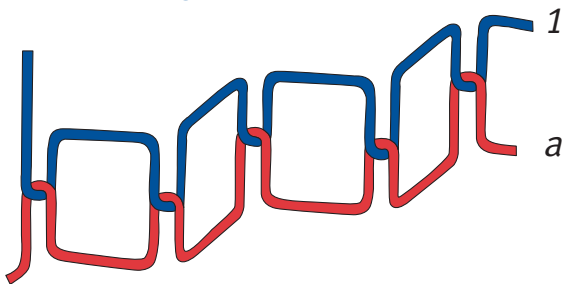

Lining is also sewn using the double chain stitch (stitch type 401) or safety stitch (401.503 or 401.505).

3.3 Stitch density

Primarily stitch density depends on material, number of layers, size of the sewing thread and seam appearance (possibly decorative stitches).

In general: the higher the stitch density, the stronger the seam, since the seam becomes more tear-proof and elastic. Therefore, when sewing seams that are exposed to much wear and tear, stitch density should be high.

Care must be taken, however, which stitch density is appropriate for which material. In the case of leather in particular, there is the danger that too high a stitch density when using a cutting point perforates the material. In order to maintain a high stitch density, a needle with a suitable direction of cutting must be selected.

3.4 Thread tension

The necessary thread tension depends on fabric, sewing thread and sewing machine.

It is assumed that a sewing thread has a certain amount of elasticity of its own. If this is too high, however, undesired puckering can occur. An optimal thread tension is a precondition for the right thread distribution and sufficient thread in the seam. Generally, thread tension should be as low as possible in order to produce a smooth and tidy seam appearance and avoid tension puckering in the seam.

Machine

4. Sewing machines for the manufacturing of luggage, bags, travel and leather accessories

For sewing luggage, bags, travel and leather accessories, mainly heavy 1- or 2-needle double lockstitch machines are used. In addition, there are free-arm and/or postbed sewing machines for stitching closing seams on small parts and round parts.

Sometimes, automats such as short-seam automats and programmable sewing automats with changeable sewing direction are used (e.g. for watch straps and belts).



Flatbed Sewing Machine

Closing and topstitching seams



Free-Arm Sewing Machine

Three-dimensional sewing, closing seams on curves



Postbed Sewing Machine

Stitching of closing seams on small sections and curved parts

Sewing Automats

For topstitching (decorative seams) more and more automatic machinery is used which is programmable for multidirectional sewing

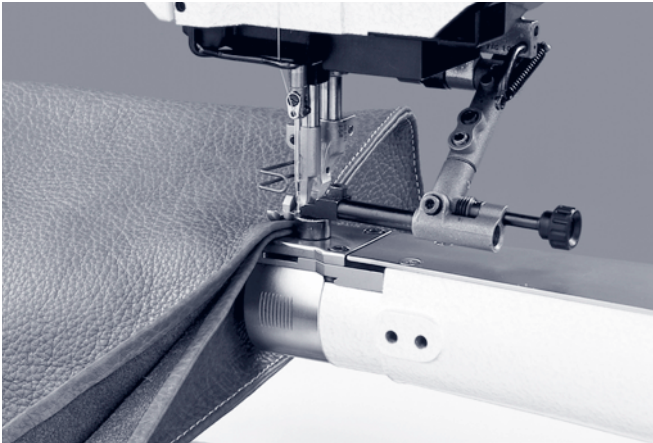

Closing and at the same time topstitching of the seam (8967-160182)
Source: Dürkopp-Adler AG



Stitching of a portefeuille-seam (N291-185182)
Source: Dürkopp-Adler AG

4.1 Feed

In the manufacture of luggage, heavy sewing machines are often used with correspondingly coarse-toothed feed-dogs and throat plates.

When sewing sensitive synthetic materials or leather, care must be taken that the feed does not damage the material due to high presser foot pressure or there is too much area pressure. There are several types feed that must be adjusted to the fabric and the sewing operation in order to achieve an optimal and pucker-free seam appearance.



Compound feed with alternating presser foot top feed

For displacement-free and smooth sewing of heavy and/or feed-critical materials



Compound and roller feed

For seams in a difficult or tight and three-dimensional environment



Needle feed, roller top feed and roller bottom feed

For displacement-free sewing of decorative and joining seams

4.2 Throat plate/Throat plate aperture size

All sewing machines and sewing automates are fitted with specific sewing accessories for the particular use or the sewing operation for which they are intended. These include the type of feed on the machine and the throat plate aperture which are adjusted to the needle sizes available for use.

The size of the stitch hole must not be too small for the size of the needle so that needle and thread can pass the stitch hole unimpeded. If the throat plate opening is too big however, the material may be pulled into the stitch hole and cause material damage and even skip stitches, since the pulled in material prevents stitch formation.

Needle size /Throat plate aperture size						
Needle size [NM]	70	80	90	100	110	120
Throat plate aperture size [mm]	1,20	1,40	1,60	1,60	2,00	2,00

Relationship of needle size to throat plate aperture size

4.3 Sewing speed

Although most machines have a maximum speed of 1,600 and up to 4,000 stitches/min, sewing speed is reduced. For sewing luggage about 600 – 2,000 stitches/min are deployed. Sewing speed depends on the machine used as well as the particular sewing process. In the case of short seams and difficult pieces with curved and corner seams, effective sewing speed often lies below the maximum possible sewing speed.

A certain sewing speed must not be exceeded due to heat development in the case of previously stuck together parts, otherwise the needle becomes sticky or material layers stick together.

In order to prevent sticky residue on the needle, when using neoprene glue sewing speed should be no higher than 2,000 stitches/min, and when using polyurethane-glue, sewing speed should be no higher than 650 stitches/min.

5. Our advice

You can achieve damage-free quality seams if all the sewing parameters are precisely coordinated with one another.

Material, needle, thread and machine are the key variables. The **SCHMETZ SERVICEHOUSE** offers various service packages:

From recommending the ideal needle for your fabrics to sending out sample needles and providing assistance with special sewing requirements. In addition the **SCHMETZ SERVICEHOUSE** offers competent on-site advice on your production line and training courses for your employees.

**Challenge us –
let us show you our competence!**

Form to copy and fax: + 49 (0) 24 06 / 85-186

Do you have further questions about sewing luggage, bags, travel and leather accessories?

Would you like support in solving your individual sewing problem?

Would you like recommendations on needle selection and sewability of your fabrics in advance of production?

Challenge the **SERVICEHOUSE** experts and take advantage of our offer.

We will be pleased to send you information on:

Our range of service:

CONSULTING

SAMPLE NEEDLES

Sample needles, tips and information

DOCUMENTED SEWING REPORTS

Sewing reports tailored to match your sewing goods as well as solutions for your complex sewing demands

EXPRESS CONSULTING

Express consulting by phone, fax or e-mail

Company name
Attention
Position
Address
Postcode/City
Country
Phone
Fax
E-Mail

INFORMATION

SEWING FOCUS

Sewing information for special industries and applications

PRODUCT FOCUS

Product information for special industries and applications

GUIDE TO SEWING TECHNIQUES

Manual for sewing industry

TRAINING / SYMPOSIUM

TRAINING-ON-SITE

Industry specific training including the latest information on needles, threads, machines and applications

SYMPOSIUM

Interdisciplinary knowledge sharing and exchange of expertise for skilled sewing industry staff