

SEWING FOCUS

TECHNICAL SEWING INFORMATION

SERVICEHOUSE



Ladies Wear

Checklist for Sewing Ladies Wear

Sewing Parameters: SCHMETZ Tip:

Needle size	NM	SIZE
	50 – 140	5 – 22
	Depending on the thickness of the material.	
	We recommend the use of the SCHMETZ SERV 7 needle.	

Needle point In the production of ladies wear, mostly round points are used. In the production of knitted fabric however ball points must be used.

Sewing thread Needle thread and hook/looper thread are mostly continuous multi filament sewing threads made from polyester. However, cotton and polyester mixes, cotton threads and special threads made from silk are also used. Core spun threads, schappe spun threads, mono filaments and textured threads are used as well.

Machine Many processes are carried out using industrial high-speed sewing machines with stitch types 301 (double lockstitch) and 401 (double chain stitch). The comprehensive range also requires a number of automats as well as special sewing machines for closing seams and hems. The ideal sewing speed is around 3,000 – 4,000 stitches/min.

Other factors:

Thread tension The required thread tension depends on fabric, sewing thread and sewing machine. It should however be kept as low as possible in order to avoid seam puckering.

Stitch type Double lockstitch (stitch type 301), double chain stitch (stitch type 401), blind stitch (stitch type 103), types of overedge chain stitch and cover stitch (class 500 and 600); all stitch types and classes according to DIN 61400.





Stitch density The higher the stitch density the higher the elasticity and strength of the seam.
But: max. 6 – 7 stitches/cm.

Quick Reference for Typical Sewing Problems in Ladies Wear Manufacturing

Symptoms	Effect	Cause
----------	--------	-------

Skip stitches/Thread breakage

No interlacing/interlooping of needle thread and bobbin/looper thread	Reduced seam strength, especially with double chain stitch	Incorrect thread tension
Thread breakage	Sub-standard, defective seam appearance	Incorrect needle system
Ravelling of the needle thread	Opening of the whole seam especially with double chain stitch	Needle incorrectly fitted
	Thread breakage after skip stitch	Adhesion of melted residues, clogging of the needle eye and needle groove
	Jamming of the sewing thread due to stitch holes which are clogged	Use of an oversized sewing thread in relation to the needle size
	Partly or whole melting through of the needle thread	Wrong sized aperture of throat plate, material is pulled into it or jammed and prevents the loop formation
		Overheating of sewing machine needle
		Mechanical damage to needle, throat plate, feed etc.
		“Tipping over” of the needle thread loop
		Arching up of the material due to insufficient presser foot pressure
		Jamming of the sewing thread between needle and fabric
		Incorrect thread guidance

Solution			
NM SIZE	Point style	Thread	Machine
			
<p>Use the SCHMETZ SERV 7 needle</p> <p>Adjust needle size to the material and amount of layers and thread size</p> <p>Change needle regularly (after every shift or after a shorter interval depending on the stress)</p> <p>Check needle eye and groove for damage, if in doubt: change needle</p>	<p>Check point for damage</p>	<p>Adjust sewing thread size to the needle size</p> <p>Optimize thread tension</p>	<p>Optimize the hook/looper setting</p> <p>Examine the thread guiding elements</p> <p>Adjust the sewing accessories such as throat plate, feed etc. depending on material thickness and sewing thread/needle</p> <p>Change worn out or defective sewing accessories regularly, such as thread guiding elements, hook/looper, throat plate etc.</p> <p>Use the right presser foot and the right adjustment of the presser foot pressure</p> <p>Check throat plate for damage</p>

Quick Reference for Typical Sewing Problems in Ladies Wear Manufacturing





Symptoms	Effect	Cause
----------	--------	-------

Fabric damage

Symptoms	Effect	Cause
Damage to fabric	Reduced tensile strength of the material	Oversized needle and/or wrong point style
Stitch holes with melted residue of fabric threads	Sub-standard, defective seam appearance	Excessive sewing speed
Mesh damage	Reduced seam strength	Defective/worn out needles
Pulled out weft and warp threads		Unsuitable finish
Stitch holes visible, weft or warp threads destroyed		Wrong sized aperture of the throat plate
		Damaged sewing accessories such as throat plate, feed etc.

Seam puckering

Symptoms	Effect	Cause
Formation of undesirable waves along the seam	Shifting of material layers	Incorrect adjustment of the sewing accessories such as hook/looper, feed etc.
	Fit is not precise	Incorrect balance of thread tension
	Reduced seam strength	Incorrect thread guidance
		Wrong sewing accessories: too rough toothed feed, oversized aperture of the throat plate, wrong feed
		Oversized needle
		Stitch density too high
		Presser foot pressure too high
		Selection of unsuitable stitch type
		Use of an oversized sewing thread and/or wrong sewing thread

Solution			
NM SIZE	Point style	Thread	Machine
			

<p>Use the SCHMETZ SERV 7 needle</p> <p>Adjust needle size to the material and amount of layers</p>	<p>R Normal round point</p> <p>SES Light ball point</p> <p>CAUTION: After every change of shifts or in short intervals according to the needle stress we recommend to change the needle</p>	<p>Choose the right sewing thread size according to the needle size and the fabric</p>	<p>Adjust the sewing accessories such as throat plate, feed etc. depending on material thickness and sewing thread/needle</p> <p>Check and adjust the material transport</p>
---	--	--	--

<p>Use of thinner needles</p> <p>Adjust needle size to the material and amount of layers</p>	<p>SPI Acute round point</p>	<p>Optimize thread tension</p> <p>Choose the right sewing thread size according to the needle size and the fabric</p>	<p>Use of special feeds (roller or teflon foot)</p> <p>Use of special sewing accessories</p> <p>Use of fine-toothed feed</p> <p>Correct thread guidance</p> <p>Adjust the sewing accessories such as throat plate, feed etc. depending on material thickness and sewing thread/needle</p> <p>Adjust presser foot pressure</p> <p>Examine the thread guiding elements</p>
--	----------------------------------	---	--

Selection of Point Style and Needle Size

Material	Number of layers	Needle size NM / SIZE	Point style
Light fabric (for blouses)	2 – 4	50 – 70 / 5 – 10	R normal round point SPI acute round point
Medium fabrics (for suits)	2 – 4	80 – 90 / 12 – 14	SES light ball point
Heavy fabrics (for coats)	2 – 4	100 – 110 / 16 – 18	SES light ball point
Tightly woven materials (light, e. g. silk)	2 – 4	60 – 70 / 8 – 10	SES light ball point SPI acute round point
Fine knitted fabric	2 – 4	60 – 70 / 8 – 10	SES light ball point
Medium knitted fabric	2 – 4	65 – 75 / 9 – 11	SES light ball point SUK medium ball point
Coarse knitted fabric	2 – 4	75 – 90 / 11 – 14	SUK medium ball point
Fabric together with padding	2 – 4	65 – 80 / 9 – 12	SPI acute round point

General recommendation in manufacturing ladies wear:
Use of the SERV 7 needle version with the appropriate point style



Contents

1. Manufacturing of ladies wear
 - 1.1 Typical sewing problems
 - 1.2 Quality seams with the right sewing parameters
2. Selection of the right needle
 - 2.1 Needle size
 - 2.2 Point style
 - 2.3 SERV 7 needle construction
 - 2.4 BLUKOLD needle
 - 2.5 Changing of the needle
3. Selection of sewing threads and stitch parameters
 - 3.1 Composition and size of the sewing thread
 - 3.2 Stitch type
 - 3.3 Stitch density
 - 3.4 Thread tension
4. Sewing machines for the manufacturing of ladies wear
 - 4.1 Feed
 - 4.2 Throat plate/Throat plate aperture size
 - 4.3 Sewing speed
5. Our advice
6. SERVICEHOUSE –
An overview of our services

1. Manufacturing of ladies wear

The production and use of ladies wear has its origins in ancient Egypt. At the time, it consisted of a simple linen cloth wrapped around the waist.

During the course of history, clothing became more varied and its outline changed from epoch to epoch.

Today, apparel fashion is determined by individual life-style as well as special occasions and habits at work, day-to-day and during leisure time. In general, people have great awareness of fashion, since clothes are representative for the standard of living.

Today, ladies wear is characterized by exquisite fabrics, costly finishing, decorative details as well as great diversity.

The guiding principle for ladies' fashion is the active, self-confident woman who prefers the classic-elegant as well as the sporty-functional look. On the other hand, there is also a very feminine fashion that can be sophisticated, seductive and extravagant.

Nostalgic influences are reminiscent of the fashion of by-gone decades, bringing about mixing of styles and extremely contrasting lines.



1.1 Typical sewing problems

In the production of ladies wear, many different types of materials are used. They range from heavy fabrics with wool or even tweed to medium fabrics with cotton, viscose and polyester, and light fabrics such as silk and types of micro fibers. In addition, there are differences in the finish of fabrics and knitwear.

Frequent needle and sewing thread changes required by the varying demands of the material used is a protracted process. It is often neglected in order to save time and money. It is, however, decisive for a flawless seam. If this factor is not paid enough attention, the result is the most common problem in the production of ladies wear, seam puckering.

Further typical sewing problems are:

- Skip stitches/Thread breakage
- Fabric damage

1.2 Quality seams with the right sewing parameters

All sewing parameters that influence production must be carefully coordinated: material, needle, thread and machine settings. In the production of sensitive materials especially, it must be noted that material, thread and needle form an “inseparable trio”. If one parameter is changed the others must be checked and if necessary adapted.

Needle

2. Selection of the right needle

Choosing the right needle and point style for the material is extremely important for an undamaged seam and a perfect end product. The material is the main factor when choosing a point style for a particular sewing operation.

In the production of textiles, we generally recommend the use of ball points. These needles displace the weave/knitwear threads and gently push them aside. However, the combination and composition of material and number of layers are also important factors when deciding on the right needle.

2.1 Needle size

Before deciding on a point style, needle size should be determined. It is important to bring this into line with the thread so that it can pass the needle eye with as little friction as possible. As a rule, the size of the needle eye is around 40 % of the needle size (NM).

The strain put on the sewing thread becomes particularly apparent when considering that the needle thread in the case of a double lockstitch passes the needle eye 25 – 60 times in the same place until in the middle of the material it interlaces with the bobbin thread to create the stitch. The sewing thread is thus put under a lot of strain.

There is a simple test that exactly determines which needle size goes with which sewing thread: If the needle is of the right size, it should slide along the thread held at an angle by its own weight without any problems.

The material is of course an important factor when determining the size of the needle. Especially fine fabrics can benefit from the use of needle sizes NM 65 – 70. The right needle mainly prevents material damage and displacement puckering. In this context please note: The thinner the needle’s diameter (NM/SIZE) the less the individual fabric threads are displaced.

Minimal displacement prevents the fabric threads from tearing. A thin needle can thus pass the fabric threads more easily without causing damage.

You can find an overview of the recommended needles sizes in the table on page 6.

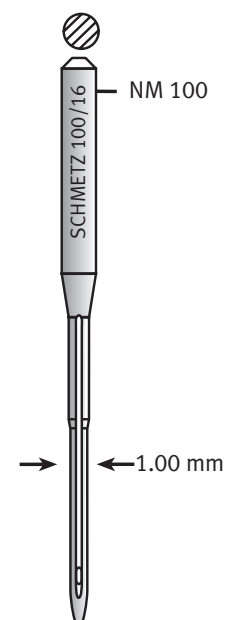

2.2 Point style

Point style is at least as important for a smooth production process and optimal end result as is the needle size. In the production of ladies wear, mostly round points are used.

The normal round point “R” with its pointed conical shape counts as the standard point style and has many fields of application. This point style is suitable for most lightweight woven fabrics. For special materials specialized point styles should be considered.

R normal round point



In the case of particularly tightly woven fabrics such as micro fibers, the “SPI” point enables exact piercing due to its very slim acute point. The acute point style can easily find its way through the very tight fabric and produces a tidy and straight seam appearance. The “SPI” point is therefore often used for topstitching seams (e.g. collars, cuffs). Seam puckering is also kept to a minimum.

SPI acute round point



In general, we also recommend the “SES” point style. Compared with the “normal” round point, the tip of the “SES” point is hemispherical and can therefore avoid material damage. At the point of penetration, a small ball point can push aside or displace fabric threads more easily.

This needle point is not only used for knitted fabrics, but also for light, tightly woven materials.

SES light ball point



Needles with a medium ball point “SUK” are even more rounded than the light ball point “SES”.

When sewing coarser knitted fabrics and firmer twill weave fabrics this needle should be used.

SUK medium ball point



2.3 SERV 7 needle construction

Apart from material damage and seam puckering, skip stitches are also a common problem. Skip stitches occur during stitch formation when the thread loop is not caught by the hook/looper, interrupting the interlacing or interlooping of upper and lower thread. Skip stitches significantly impair the run and the strength of the seam and therefore the quality of the end product.

The SERV 7 needle is a needle for special requirements. This needle version is characterized by an optimized hump scarf and blade reinforcement, both of which help to avoid skip stitches and needle breakage. This type of needle comes with various point styles that meet the demands of different materials.

SCHMETZ Tip:

Benefit 1: SERV 7 hump scarf produces optimum loop formation and prevents skip stitches.

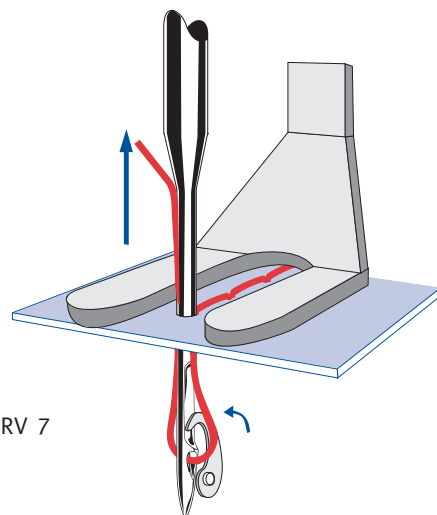

SCHMETZ SERV 7

The SERV 7 needle's blade reinforcement makes the needle more stable. It enables you to use a thinner needle and retain the stability of the needle. In order to achieve stitch holes that are as small as possible, SERV 7 in size NM 75 can be reduced to NM 65 – without impairing the stability of the needle.

In addition, the SERV 7 needle's optimized hump scarf avoids skip stitches that can easily arise with elastic materials and higher amounts of layers. The hump scarf guarantees that even in the case of only a small loop or no loop at all there is enough room between the bottom of the hump scarf and needle thread. The hook or looper can securely pick up the needle thread at any time.

SCHMETZ Tip:

Benefit 2: SERV 7 needle has higher stability increasing needle life.

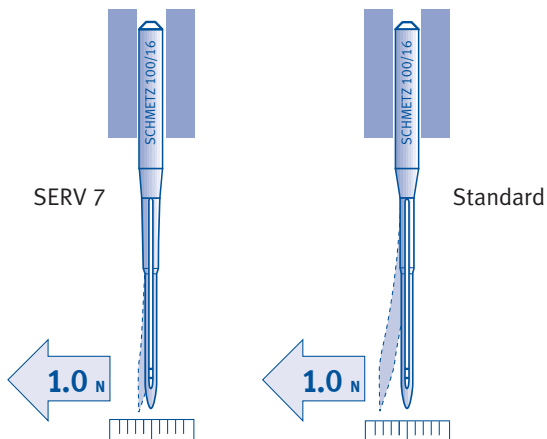

2.4 BLUKOLD needle

Special sewing problems are associated with synthetic materials or those with a high proportion of synthetic constituents, because they have a very low melting point. Due to the high temperatures that the needle reaches during the sewing process, there can be melting around the stitch hole, which can be transferred to the needle's surface as melted residue.

BLUKOLD special needles have a phosphorated surface and a Teflon® coating. This coating either does not permit any melted residue at all or else they appear much later than with a conventional (e.g. chromed) needle.

The needle remains “clean” for longer – skip stitches and thread breakage occur significantly less often.

This enables a steady sewing process.

During the sewing process, the Teflon® coating of the BLUKOLD needle does not reduce the needle temperature, however, as is often wrongly assumed.

In order to avoid damage to the material, the size of BLUKOLD needles, too, must be matched to material and, if necessary, sewing speed must be reduced.

Care must be taken that the needle is definitely “run in” before sewing white or lightly colored materials. This means that the external BLUKOLD layer is chafed off during the needle motion by the fabric over a seam length of approx. 50 cm (20 inches), leaving “green” puncture marks. This “running in” gives the needle a darker appearance, which does not however impair its functionality in any way.

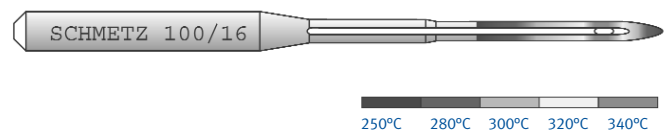

Temperature profile during the sewing process without sewing thread

2.5 Changing of the needle

Even minimal damage at the needle point causes material damage and reduces the quality of the end product. Only a flawless point can ensure that the needle can penetrate the material layers without damaging them. Therefore, the needle should be changed often and at regular intervals.

SCHMETZ Tip:

Check needle tips regularly or replace needles at regular intervals.

Sewing thread

3. Selection of sewing threads and stitch parameters

Many different materials are used for ladies wear. This in turn leads to the use of different types of yarn. Mostly, synthetic sewing yarn is used, but cotton mixes and special threads made from silk are also used. The elasticity of the seam is greatly influenced by type of stitch and thread tension.

3.1 Composition and size of the sewing thread

In the clothing industry today, mostly polyester sewing threads are used. They are far superior to conventional threads made from cotton and silk with regard to tensile strength, abrasion resistance, decay resistance and other important characteristics. Compared with the raw materials silk and cotton, they are also more cost-effective and thus more economical.

Synthetic sewing thread has tensile strength even with a smaller cross-section, allowing the use of thinner needles. It is extremely important to optimally coordinate the strength of the yarn with the material used. When producing ladies wear, the range is large, comprising very fine threads (80 dtex) as well as stronger threads (1000 (3) dtex), guaranteeing a durable seam.

3.2 Stitch type

The stitch types zig-zag, chain stitch, cover stitch and overlock are particularly suitable for ladies wear because they allow high seam elasticity. When choosing stitch type, attention must be paid that there is sufficient amount of thread. If there is not enough thread in the seam, seams can break with only minimal strain.

Stitch type 101 – single thread chain stitch
For sewing on buttons and bartacking

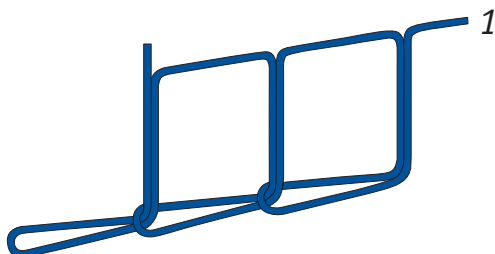

Stitch type 103 and 105 – blind stitch (without illustration)
For felling of single or folded edges (e.g. skirt hemming)

Stitch type 301 – double lockstitch
For closing and attaching seams, also for topstitching seams (e.g. topstitching of button facing, sewing on pockets)

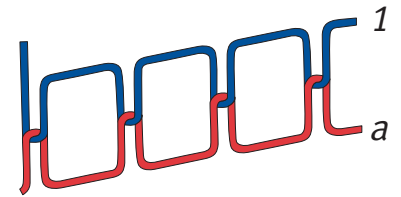

Stitch type 304 – double lockstitch (zig-zag)
For elastic joining, attaching and decorative seams (e.g. sewing of straight buttonholes)

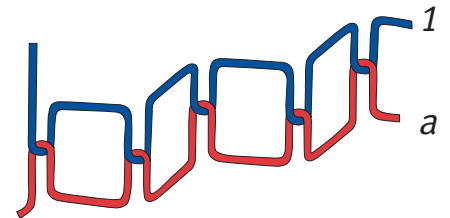

Stitch type 401 – double chain stitch
For elastic closing seams (e.g. closing side seam)

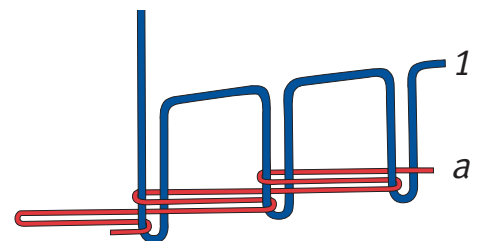

Class 500 – types of overedge chain stitch
For serging seams with high demands as well as joining and serging the fabric edges at the same time (e.g. serging trouser hem, closing side seam)

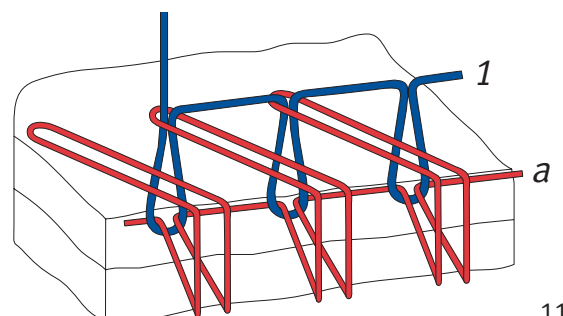

Class 600 – types of covering chain stitches

For flat seams and knitwear seams (e.g. sewing hem of a T-shirt)

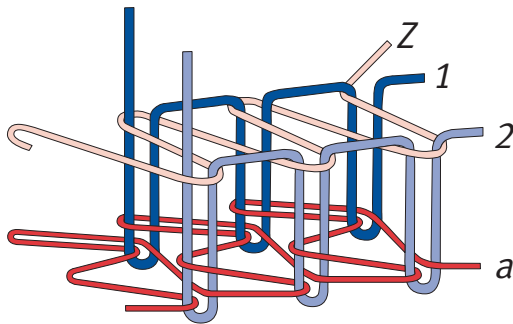

In the case of the double lockstitch, the tension setting's starting point is the bobbin thread tension, which should first of all be optimized as a precondition for a pucker-free seam. This should be chosen as low as possible. In connection with fine threads, values of up to 20 cN can be realized.

Compared with bobbin thread tension, needle thread tension is 2 to 3 times higher. In coordination with the bobbin thread it should be chosen so that stitch interlacing of needle and bobbin thread is situated in the middle of the material.

In the case of the double chain stitch, thread tension is mostly low compared with the double lockstitch. This is because with the double chain stitch interlooping is not pulled into the material and thus requires less force. When using this type of stitch, care must be taken that thread tension is kept as low as possible and that the needle thread is at least visible as a small dot at the double cross-section at the bottom side of the fabric. In the case of particularly sensitive fabrics, it makes sense to loosen tension thread so that the needle thread forms a small loop at the bottom side.

The bobbin's winding tension should be set so that an even winding appearance is achieved and a flawless sewing process is ensured. Depending on the machine, ideal winding tension is between 20 and 30 cN.

3.3 Stitch density

Stitch density should be coordinated with material composition, the number of layers, and the desired strength and elasticity of the seam. At the same time, thread size is a further criterion for optimal stitch density.

The number of stitches per cm (inch) further determines seam strength and elasticity. Stitch density directly influences tension as well as displacement puckering. Increasing stitch density leads to a greater amount of thread in the seam, which in turn decreases the risk of tension puckering.

If the fabric tends towards displacement puckering, an increase in stitch density displays correspondingly greater seam puckering. This can usually be solved by using thinner needles of NM 70 or thinner together with suitably fine thread.

An increase of stitch density by 30% (e.g. from 3 to 4 stitches/cm (0.4 inches)) increases the strength of the seam by 30%. An increase in stitch density thus often enables the use of a finer thread.

3.4 Thread tension

Thread tension, too, influences the elasticity of the seam. Generally, thread tension should be as low as possible in order to produce a smooth and tidy seam appearance and avoid tension puckering in the seam. The exact thread tension depends on fabric, sewing thread, material, stitch type as well as needle.

Machine

4. Sewing machines for the manufacturing of ladies wear

Apart from needle and sewing thread, machine settings too are a decisive factor of the quality of the sewing result.

In the production of ladies wear, mostly industrial high-speed machines with stitch type 301 and 401 are used that have the accessories for the required sewing operation. Nowadays, however, more and more processes are done using automats.



Pict. 1: Button sewing machine (3307)

Source: Pfaff AG



Flatbed Sewing Machine

Closing and attaching seams
topstitching



Postbed Sewing Machine

Closing and attaching seams
on curved pattern,
sewing in sleeves



Free-Arm Sewing Machine

Securing closing seams on
round parts



Mono Block Sewing Machine

Serging and closing of knitwear
and fabric edges

Sewing Automats

(see pict. 1)

Sewing on pockets and
buttons, button holes, bartack-
ing, pipe sewing, production of
darts and pleats

4.1 Feed

In order to avoid feed puckering, the feed dog must not be too coarse.

For thin light fabrics, fine-toothed feed dogs have proved to be the best. Coarsely toothed feed dogs on the other hand favor puckering.

The height of the feed dog depends on the surface and density of the fabric. In the case of smooth light fabrics, to 1/3 of the height of the teeth above the throat plate is sufficient, for fluffy materials feed dog height must be adjusted accordingly in order to ensure material feed.

Decreasing the height of the teeth above the throat plate allows the presser foot pressure to be decreased and thus decreases the risk of feed puckering.

Last but not least, as with the needle, it must be considered that even small damages to feed dog, throat plate and hook/looper can lead to material damage.



Drop feed

For sewing fine to medium materials
without displacement



Compound feed or bottom and needle feed

To ensure feed of materials causing feed difficulties, good for closing works (ensures uniform stitches, facilitates corner sewing)



Bottom feed with clamp or rail, top feed with clamp or rail

For displacement-free and precise sewing according to a predetermined seam pattern



Drop feed and roller top feed

For sewing feed-critical materials and feed-critical seams



Bottom feed and foot top feed

For sewing fine and feed-critical fabrics; good for sewing in constant and partial extra width

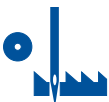

Bottom feed, needle and roller top feed

Smooth displacement-free seams



Differential bottom feed and alternating presser foot top feed

For sewing in constant and partial extra width



Differential bottom feed and presser foot top feed

For sewing in constant and partial extra width



Compound feed with alternating presser foot top feed

For sewing in constant and partial extra width

4.2 Throat plate/Throat plate aperture size

The choice of throat plate is determined by type of feed, needle size as well as additional accessories.

The throat plate aperture size must fit the size of the needle. If the throat plate aperture is too large there is a risk that the material is pushed into the throat plate through the needle; the result are skip stitches and material damage.

At needle size of NM 65 – 70 a throat plate of 1.0 – 1.2 mm is the ideal precondition for avoiding seam puckering. A throat plate of over 2 mm carries the risk that the fabric is pushed through the needle into the throat plate developing a funnel. This results in seam puckering and skip stitches.

Needle size /Throat plate aperture size						
Needle size [NM]	70	80	90	100	110	120
Throat plate aperture size [mm]	1.20	1.40	1.60	1.60	2.00	2.00

Relationship of needle size to throat plate aperture size

4.3 Sewing speed

Given the wide variety of materials and processes, no general statement can be made about optimal sewing speed. Light to medium fabrics can be sewn with a speed of up to 8,000 stitches/min. Heavier and finished materials can only be sewn properly and without getting damaged at a low sewing speed. High speeds only lead to diminished quality such as thread breakage, skip stitches and needle breakage. Depending on the number of layers and the position of the seam, a speed of 1,000 to 2,800 stitches/min can be reached.

It must be noted however that in the case of synthetic materials (e.g. coated) thermal damage in the form of needle smearing and material damage can occur, if sewing speed is too high.

In general, sewing speed must always be coordinated with material, type of stitch and number of layers. A guiding principle is: optimal quality together with high productivity.

5. Our advice

You can achieve damage-free quality seams if all the sewing parameters are precisely coordinated with one another.

Material, needle, thread and machine are the key variables. The **SCHMETZ SERVICEHOUSE** offers various service packages:

From recommending the ideal needle for your fabrics to sending out sample needles and providing assistance with special sewing requirements. In addition the **SCHMETZ SERVICEHOUSE** offers competent on-site advice on your production line and training courses for your employees.

**Challenge us –
let us show you our competence!**

Form to copy and fax: + 49 (0) 24 06 / 85-186

Do you have further questions about sewing ladies wear?
Would you like support in solving your individual sewing problem?
Would you like recommendations on needle selection and sewability of your fabrics in advance of production?
Challenge the SERVICEHOUSE experts and take advantage of our offer.

We will be pleased to send you information on:

Our range of service:

CONSULTING

SAMPLE NEEDLES

Sample needles, tips and information

DOCUMENTED SEWING REPORTS

Sewing reports tailored to match your sewing goods as well as solutions for your complex sewing demands

EXPRESS CONSULTING

Express consulting by phone, fax or e-mail

INFORMATION

SEWING FOCUS

Sewing information for special industries and applications

PRODUCT FOCUS

Product information for special industries and applications

GUIDE TO SEWING TECHNIQUES

Manual for sewing industry

TRAINING/SYMPOSIUM

TRAINING-ON-SITE

Industry specific training including the latest information on needles, threads, machines and applications

SYMPOSIUM

Interdisciplinary knowledge sharing and exchange of expertise for skilled sewing industry staff



Company name
Attention
Position
Address
Postcode/City
Country
Phone
Fax
E-Mail